

Maintenance & Operation Manual for

Aluminium Windows & Doors



Contents

| | |
|--|-------------|
| 1. Cleaning & Maintenance of Powder Coated Aluminium | Pages 1-2 |
| 2. General Maintenance and Trouble Shooting | Pages 3-5 |
| 3. Operating and Maintenance Instructions for Window Locks & Handles | Pages 6-7 |
| 4. Operating and Maintenance Instructions for Hinges & Restrictors | Pages 8-10 |
| 5. Operating and Maintenance Instructions for Trickle Vents | Page 11 |
| 6. Operating and Maintenance Instructions for Tilt & Turn Windows | Pages 12-13 |

The Information in this manual is for guidance only.
We reserve the right to alter any specifications without notice due to continual product improvement.

Cleaning Information

It is said that the last person to touch a window or door has the greatest influence over its performance. Whilst this may be true in the short term, a product's lifecycle can be prolonged by regular and correct maintenance. This may take the form of lubrication, cleaning or adjusting by trained personnel and may vary according to the location, use and environment of the finished building.

Here we highlight the key elements of our products that require care and attention. We have consulted with the major manufacturers of hinges, handles and hardware to create this comprehensive (but not exclusive) guide.

All products are finished to the highest specifications and in accordance with the relevant British Standards for Painted and Anodised surfaces.

Installation/Post Installation

Mortar, plaster etc. must be immediately removed from all painted or anodised surfaces by washing down with warm water containing a mild detergent, taking care not to scratch the surface. Stubborn marks may be carefully tackled with a renovating cream and non-abrasive cloth. It is recommended to test on a hidden or inconspicuous area first to ensure satisfaction with result.

On no account are Alcohols, Esters or Ketones or other Organic solvents to be used, nor are polishes containing hard abrasives.

Modern powder coatings applied to architectural aluminium are similar to the types used on motor vehicles and therefore require the same degree of care and attention that people typically lavish on their car bodywork. The frequency of cleaning relates directly to the decorative standard that the householder wishes to maintain and also the particular environment where the units are situated.

Hinges and locking mechanisms should be inspected to ensure they are free from any debris that might affect their performance. Moving parts should be lubricated with the appropriate product as given on the next page.

Ongoing Care

All products should be washed down with warm water containing a mild detergent at least once a year. In areas where airborne contaminants are more concentrated than usual - near the sea, around swimming pools, or in place where industrial air pollution is a known hazard - the products should be cleaned every three months or more frequently if requested by the powder coat manufacturer for that specific location.

Painted surfaces that become marked should be treated as above. Scratches or chips may be touched in by brush using a colour matched paint - the manufacturer can supply small bottles of paint to match the stock colours it uses ie RAL9910 Hipca White as standard. Cleaning and maintenance must be carried out in accordance with the powder coat manufacturers' specification.

Anodised surfaces that have become heavily contaminated may be restored by gently rubbing them with a 'Scotchbrite' pad then drying off with a soft cloth. Application of a lanolin based cream after cleaning will give added protection.

Foiled surfaces may be touched up using the correct pens available from the manufacturer.

Finishes

Cleaning & Maintenance

Powder Coatings are organic coatings that need to be cleaned and maintained regularly to ensure that the decorative and protective properties of the coating are retained. The frequency of cleaning depends upon the environment in which the coating is in service.

Cleaning of the coating is an important part of the routine maintenance of any building. It is for this reason that we advise that only companies who specialise in this type of work are used for large cleaning operations.

The best method of cleaning is by regular washing of the coating using a solution of warm water and mild detergent. All surfaces should be cleaned using a soft cloth or sponge, using nothing harsher than natural bristle brushes (Cleaning of window sections etc. can be conveniently carried out at the same time as glazing cleaning).

If the atmospheric pollution has resulted in heavy soiling of the coating, then nothing harsher than white spirit should be used for cleaning. Do not under any circumstances use strong solvents or solutions containing chlorinated hydrocarbons, esters, ketones, abrasive cleaner or polish.

The frequency of cleaning depends in part on the standard of appearance that is required and also the requirements to remove deposits that could, during prolonged contact with either the powder film or the metal substrate, (if exposed) cause damage.

In hazardous environments the normal frequency of cleaning should be at a maximum of three monthly intervals. However where there is high atmospheric pollution or an extremely hazardous atmosphere (i.e., a combination of factors above or others) the period between cleaning should be reduced.

Where the atmosphere is deemed to be non hazardous, e.g., rural or a "normal" urban environments, then the period between cleaning can be extended up to a maximum of 18 months. However, if heavy soiling occurs more regular cleaning is required.

Routine Maintenance & Trouble Shooting



Routine Maintenance

The hardware fitted to products do not need 'calendar' servicing but should be maintained on an 'as necessary' basis. Thus items such as door locks, friction hinges, and reversible window gear which have been lubricated in manufacture and/or installation should be treated with the appropriate lubricant when they show signs of stiffening up in use or they have been left unused for a considerable time.

A list of appropriate lubricants is given below:

| | |
|---|--|
| Hinge pivots, Handles, Locks | Light Machine Oil |
| Hinge channels | Vaseline |
| Cylinder Locks | Graphite or PTFE based Lubricant |
| Vertical Sliding Window Balances (VSW) | Torso - Castrol RustiloDWF Others - Multipurpose grease |

When cleaning the products it is a wise precaution to check that all hardware fixing screws are tight, connections between VSW balances and sashes remain correct, safety stops/catches/latches are in place, and that all parts are free from damage.

At the same time, and at least annually, make sure that drainage paths are not blocked by airborne debris or other 'foreign' bodies.

Trouble Shooting

Intermittent operation or sudden unexplained impairment of the functioning of any item of hardware should be investigated **immediately** by a person familiar with the product **and repairs effected before user safety or product function is jeopardised.**

Replacement of faulty or damaged parts should be carried out by an experienced person using the correct parts.

Where an item is still covered by the warranty given by the fabricator or installer of the product requests for remedial work under such guarantees must, in the first instance, be referred to that person or company.

Hinges



Maintenance and Lubrication

As with most mechanical devices, hinges require periodic maintenance and lubrication. The hinge in general and particularly the pivots, sliding shoe and track must be kept free from dirt, debris and any obstructions at all times.

At Time of Installation - Lubricate all pivot points with light machine oil and wipe away excess, one drop per pivot is sufficient. We suggest one of the following lubricants or equivalent:

- General light engineering oil with corrosion inhibitors such as Castrol Everyman or 3 in 1 oil (available in aerosol can for convenience). **Note:** Solvent based aerosol sprays e.g. WD40 are **not** suitable for this application

Every Five Years - Carry out the following checks every five years:

- Clean any dirt or debris from the hinge and clear any obstructions from the pivots, sliding shoe and track
- Apply lubrication detailed above
- Check the tightness and security of all fixing screws and rivets

Corrosion Resistance

Some surface discolouration is to be expected.

If a hinge is fitted in an area where it is exposed to a corrosive atmosphere, e.g. salt laden sea air in coastal locations, we recommended that in addition to the general maintenance and lubrication:

- All metal surfaces are lightly coated with lubrication oil or sprayed with a proprietary anticorrosion spray. It is important to follow the manufacturer's instructions for any products used
- Maintenance operations may need to be carried out more frequently. This is dependent on the severity of the prevailing conditions

Other Hardware



Locking Mechanisms & Multi-Point Door Locks

- End guides and screw bushes should not be over tightened to impede the smooth operation of the bars
- Final adjustment should be made upon installation to ensure positive engagement of bars or rods into keeps
- The use of the correct sealing gasket will enhance the weather sealing and operation of the lock
- All parts should be lightly lubricated twice per year and surfaces wiped with a clean cloth

Care & Maintenance Instructions

To ensure that your window espagnolette functions correctly, it is important that the following maintenance procedure is carried out at least once a year:

- All fittings must be regularly inspected to ensure that they are firmly fixed. Where necessary fixing screws should be tightened by a suitably qualified person
- All handles and locking mechanisms must be lubricated
- Ammonia based and abrasive cleaning fluids should not be used on any hardware, only use cleaners that have no effect on the corrosion protection properties of the fittings

A few tips to keep your lock working smoothly:

- Use 3 in 1 oil periodically on all rivet and compression roller points
- Keep faceplate & keep surfaces clean from dust by wiping with a damp cloth

Care and maintenance instructions

To ensure that your window espagnolettes function correctly, it is important that the following maintenance procedure is carried out at least once a year.

- ❑ All fittings must be regularly inspected to ensure that they are firmly fixed. Where necessary fixing screws should be tightened by a suitably qualified person.
- ❑ All handles and locking mechanisms must be lubricated as shown. **DO NOT LUBRICATE THE FRICTION HINGES.**
- ❑ Ammonia based and abrasive cleaning fluids should not be used on any hardware, only use cleaners that have no effect on the corrosion protection properties of the fittings.

Offset Espagnolette

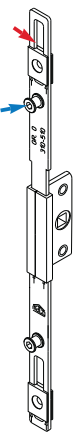

Inline Espagnolette

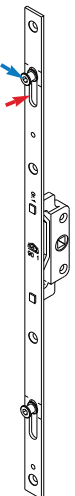

Shootbolt Espagnolette



Handles

Lightly lubricate (twice a year) with a light machine oil between the handle and backplate.



Only clean the handle with a soft damp cloth.

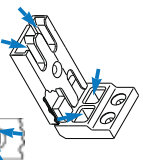

→ Grease with acidfree lubricant (e. g. Petroleum Jelly).

→ Place a few drops of a light machine oil in all guide slots.

Operating and Maintenance Instructions

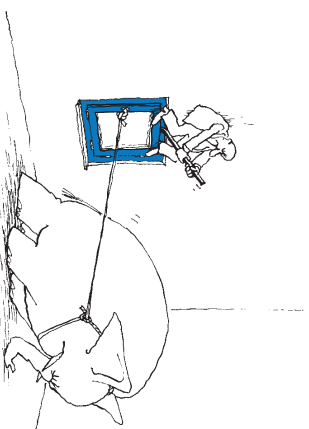

Window Espagnolettes

Advice on your Windows

- ★ Your Windows have been fitted with high quality Espagnolette/shootbolt locking mechanisms. They are simple and easy to operate, despite this it is important that you read these instructions carefully to ensure that they are operated and maintained correctly.
- ★ Do keep these instructions handy for future reference. Please ensure that all users are made aware of their contents.
- ★ By following these guidelines you will ensure that your windows remain in good working order.

Operating Instructions

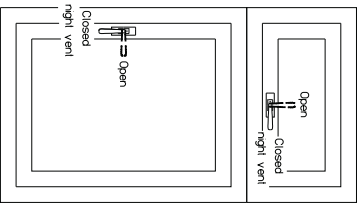

Push button on handle (if applicable) rotate handle 90 degrees and push window open.

To close the window pull the window closed and rotate handle back through 90 degrees.

To locate the window in the night vent position open the sash approximately 15 mm and rotate the handle.

Adjusting the espagnolettes

The locking cams on the espagnolettes are adjustable to allow the contact pressure between the sash and the frame to be altered.

Standard cam adjustable with a 9 mm spanner

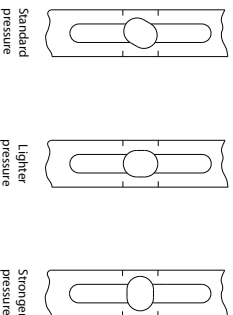

Mushroom cam adjustable with a 4 mm allen key

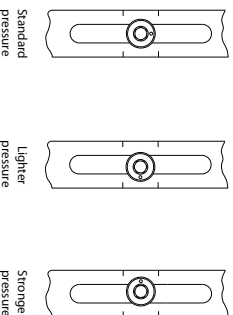

User Information

- ★ Do not apply additional loading to the sash.
- ★ Do not force the sash past its opening edge.
- ★ Do not wedge the sash open.

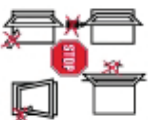

- ☒ An injury can be caused if you place any part of your body in the opening between the sash and the frame.
- ☒ Danger of falling out.
- ☒ Danger of being injured due to the effect of the wind.

General Guidelines for your windows

A good window does more than let in light and air; it is a structural unit which has high technical demands made on it. The fittings must be maintained according to these instructions coupled with periodical checks of the glass and weather seals, etc. Any faulty components should be replaced immediately. We do not recommend the use of caustic cleaning agents to clean your windows, use only water with a mild soap solution.

For security reasons it is advisable that windows are not left in the night vent position – when the room is left unoccupied.

If the sash is clashing with the frame or striker plates, the window must be adjusted by a suitably qualified person.

Hinges and Restrictors

Cleaning, Maintenance and Lubrication Instruction

Periodic cleaning, maintenance, lubrication, adjustment and checks for all hinges and restrictors

1. Clean all dirt, dust and debris from all parts of the products and any obstructions away from the pivoting and sliding parts.
 - a. Use a vacuum cleaner or small soft brush to remove dry materials.
 - b. Non abrasive, neutral acidity, non corrosive cleaning fluids or detergent and water solution can be used if necessary to remove any remaining contamination.
 - ❑ Allow the hinges to dry before proceeding to step number 4, below.
2. Check that all fixing screws are present and are securely and fully tightened.
3. Check that other hardware fitted to the window assembly.
e.g. locking mechanism(s), handles, motors, etc. are operating correctly.
4. Lubricate all pivoting and sliding parts of the products using good quality light machine oil, such as 3 in 1 Oil or similar.
 - a. One drop per pivot or sliding part is sufficient.
 - b. **DO NOT** use WD40 type or silicone based type maintenance spray products for lubrication purposes.
5. Wipe any excess lubricating oil over the surfaces of the hinge mechanism links using a soft lint free cloth.
6. Check for correct and smooth operation of the vent.

WINDOW USER INSTRUCTIONS

HANDLE OPERATION

All downstairs windows have lockable handles and all upstairs windows have non-lockable handles. To open windows push the button in, turn the handle (See Figs. 1 & 2) and push the window open. To close the window pull the window shut and return the handle back to the closed position.

Opening the Window

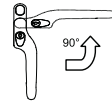

Fig. 1
Side Hung Windows

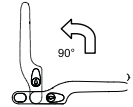

Fig. 2
Top Hung Windows

SECURITY LOCK/NIGHT VENT POSITION

By turning the handle, the security lock is operated; upstairs windows have a night vent position where the locking cam is located in an offset slot in the keep. This means that the window can be set in a position that allows more airflow into the room. The handle must be fully closed when the window is set in the night vent position. **Windows are not secure in this position.**

FIRE ESCAPE WINDOWS

If no child safety restrictor is fitted the fire escape position is achieved by fully opening the window to 90°. (See Fig. 3) However if a child safety restrictor is fitted the operation will be to open the window to the stop position on the sprung loaded arm. (See Fig. 6) Pull the window closed slightly and release the arm from the stud, the window will then fully open. When the window is closed the restrictor will self relocate.

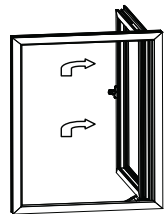
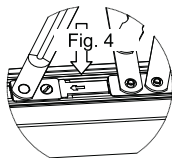

Fig. 3

EASY CLEAN OPERATION



On fire escape windows the easy clean position is achieved by opening the window fully. To gain access to clean the outside of the window from within, open the window fully to the egress position. Slightly close the window to relieve the pressure from the hinge mechanism. Depress the buttons (See Fig. 4) in the hinges at the top and bottom of the window and then sliding the vent over (See Fig. 5) to give a suitable gap. When the window is closed the buttons will self relocate. On standard windows when fully opened a gap will automatically be achieved which will give access to clean the outside of the window from within.

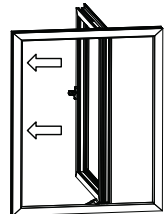

Fig. 5

RESTRICTED WINDOWS

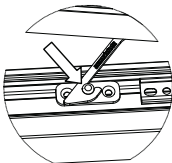

Fig. 6

Child Safety Restrictor

This may be fitted to Standard or Fire Egress windows to restrict the initial opening up to 100 mm for child safety, as defined in British Standards. To release the restrictor, open the window to the stop position on the sprung loaded arm. (See Fig. 6)

Pull the window closed slightly and release the arm from the stud, the window will then fully open. When the window is closed the restrictor will self relocate.

Built in Restrictor

This may be fitted to Standard windows to restrict the initial opening up to 100 mm for child safety, as defined in British Standards. To release the built in restrictor open the window to the stop position, pull the window closed slightly and depress the lever. (See Fig. 7) The window will now fully open, when the window is closed the built in restrictor will self relocate.

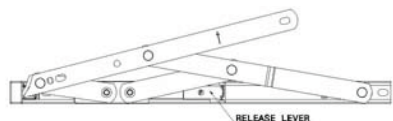

Fig. 7

CAM ACTION FRICTION SLIDER ADJUSTMENT

Adjustment of the Cam Action Friction Slider

Note: A suitable flat bladed screw driver will be required to adjust the Cam Action Friction Slider.

1. Open the window to a position where the gold coloured component is fully accessible.
2. Insert the blade of the screw driver into the slot of the gold component.
(As shown in Fig. 1)

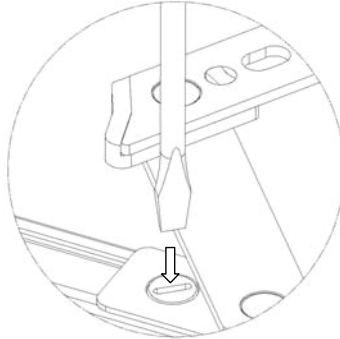

Fig. 1

3. Turn the screw driver in a clockwise direction to add friction to the operation of the hinge.
(As shown in Fig. 2)

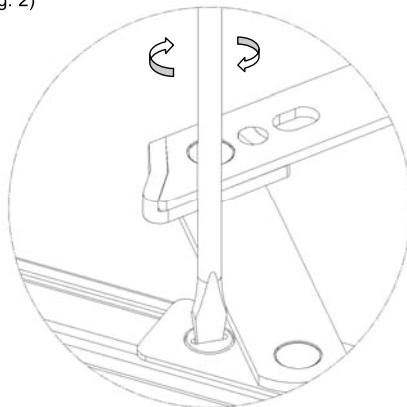

Fig. 2

Note: If the operation of the hinge becomes too stiff, repeat stages 1 and 2 then turn the screw driver in an anti-clockwise direction.

It is the responsibility of the user to ensure that this document is at the latest issue.

Due to our policy of continual product improvement we reserve the right to alter specifications without notice.

It is the responsibility of the window manufacturer to ensure that the finished window meets the required performance and safety specification.

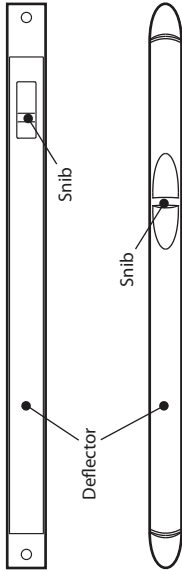

(Trimvent 4000/TV 90/TV SW/TV Patio only)
(for Trimvent SM - snib at far end of product)

(Trimvent Select Vents Only)

For best performance, silicone sealant should be used on external canopy (in sealant groove).

Operation:

1. Open & Close by pushing snib on deflector left or right respectively.
2. Deflector can be tilted to direct air in the desired direction (TV Select vents only, except TV Select Xtra).
3. Do not block ventilator or external canopy/grille.

* Keep vent open as much as possible for a healthy indoor environment *

Maintenance:

1. Wipe Ventilator (and Canopy/Grille if accessible) clean with a damp cloth. Frequency will depend on local conditions.
2. Clean away blockages with a soft brush.
3. Do not lubricate

Tilt & Turn Window

Operating, Maintenance and Safety Instructions

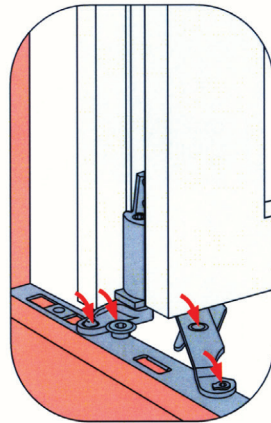
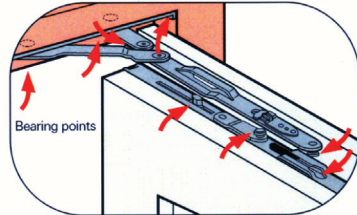
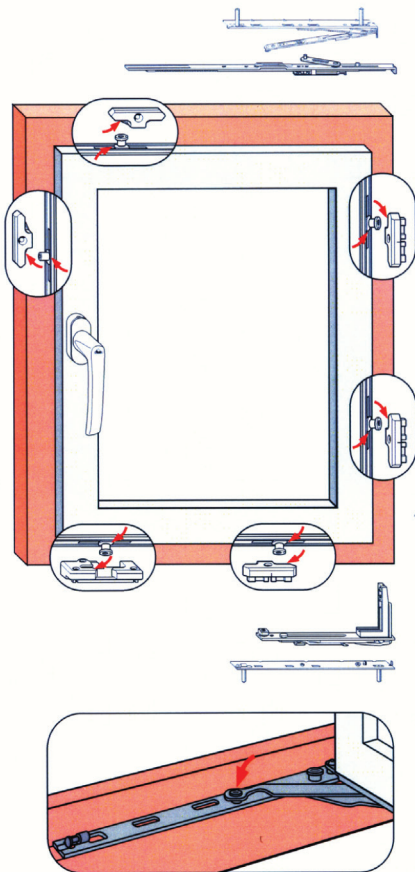

Maintenance

By means of regular **greasing and oiling*** (at least once a year) all operation-relevant components in the sash and frame, you maintain the smooth operation of your Roto hardware and you protect against premature wear and tear. Security strikers made of steel require continuous greasing in order to avoid unnecessary abrasion. In addition, the individual screws are to be checked. Possible loose screws or broken off screw-heads are to be tightened or replaced immediately by a specialised company.

* Please use acid free and non-resinous grease and/or oil from a specialised dealer.

Tökyô Series

TBT4 - Locking tilt-before-turn handle
HOPPE aluminium locking TBT (Tilt-Before-Turn) window handle for tilt-and-turn windows, Tökyô Series.
The new TBT4 offers both safety and security. The handle can be locked in the closed position and when unlocked, the handle moves freely to 90° to the tilt position. The turn position is accessed by a simple quarter turn of the key. The handle automatically returns to the tilt safe position when the window is closed.

Operation

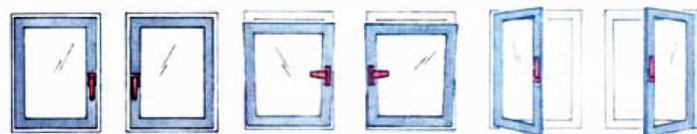

Avoid mishandling



In order to preserve **functionality** of your window and to guarantee **security**, it is imperative the directives listed below are observed.

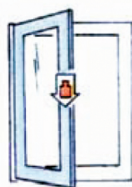

The window sash may not be burdened with additional weight.

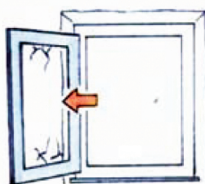

Do not allow the sash to hit or press up against the window reveal.



Do not place any objects between the sash and frame.



Where small children or mentally handicapped persons have access to the window, the sash is to be safeguarded against turning, for example with a child-safety lock (inhibits turn mode, permits tilt-mode) or key-lockable handle.

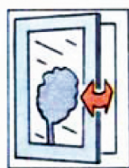

Do not leave sashes open in the turn mode during strong winds.



Caution! A slamming sash can lead to injuries. While closing, do not grasp between the sash and frame.

